

Max. Rozměry / max. Abmessungen
1993 x 1323 x 2157

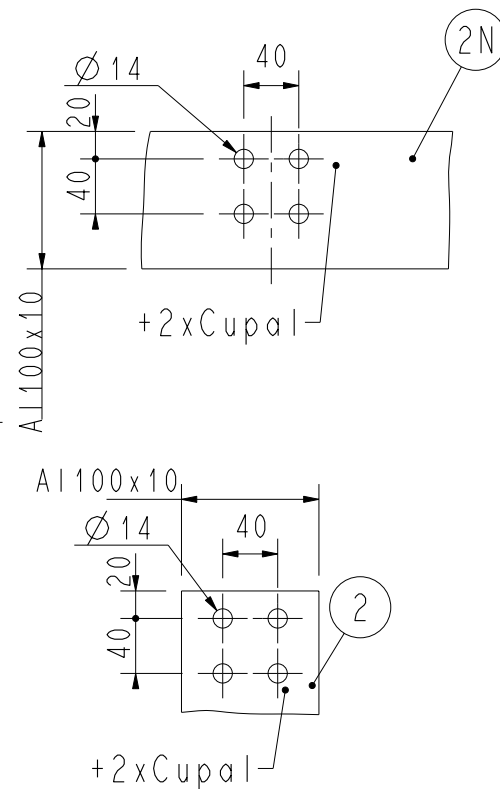
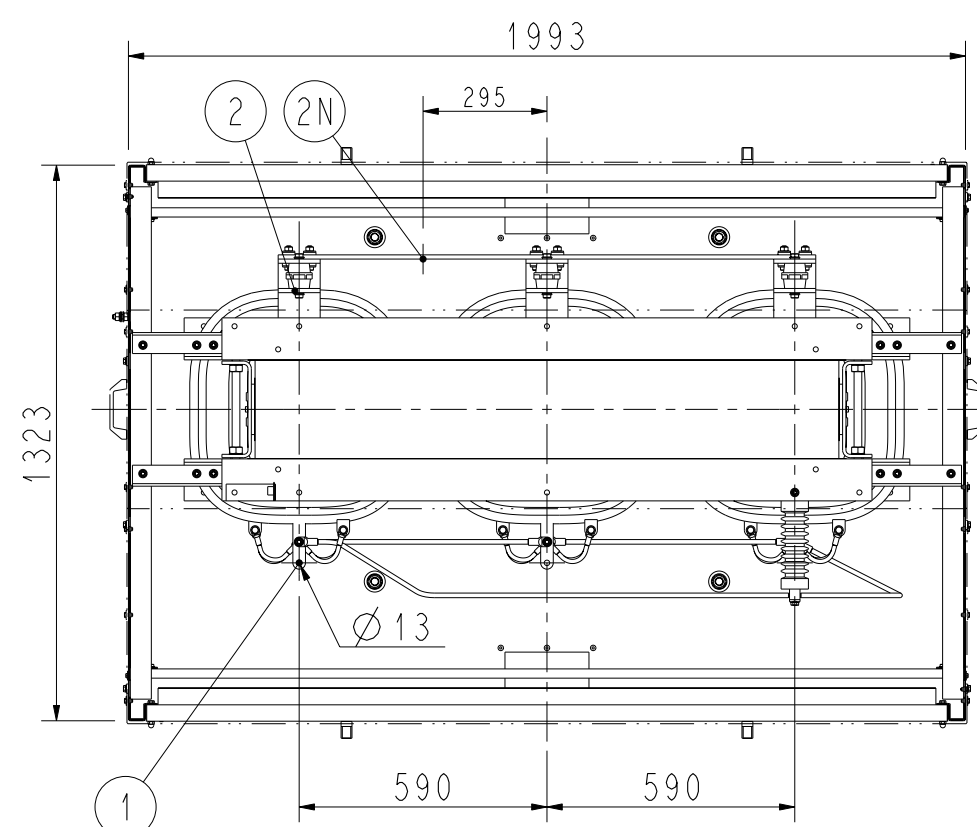
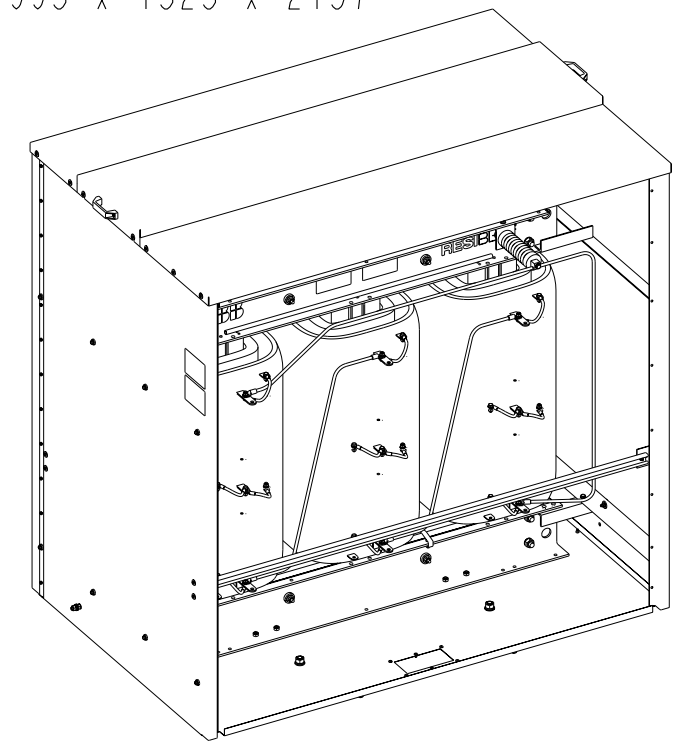
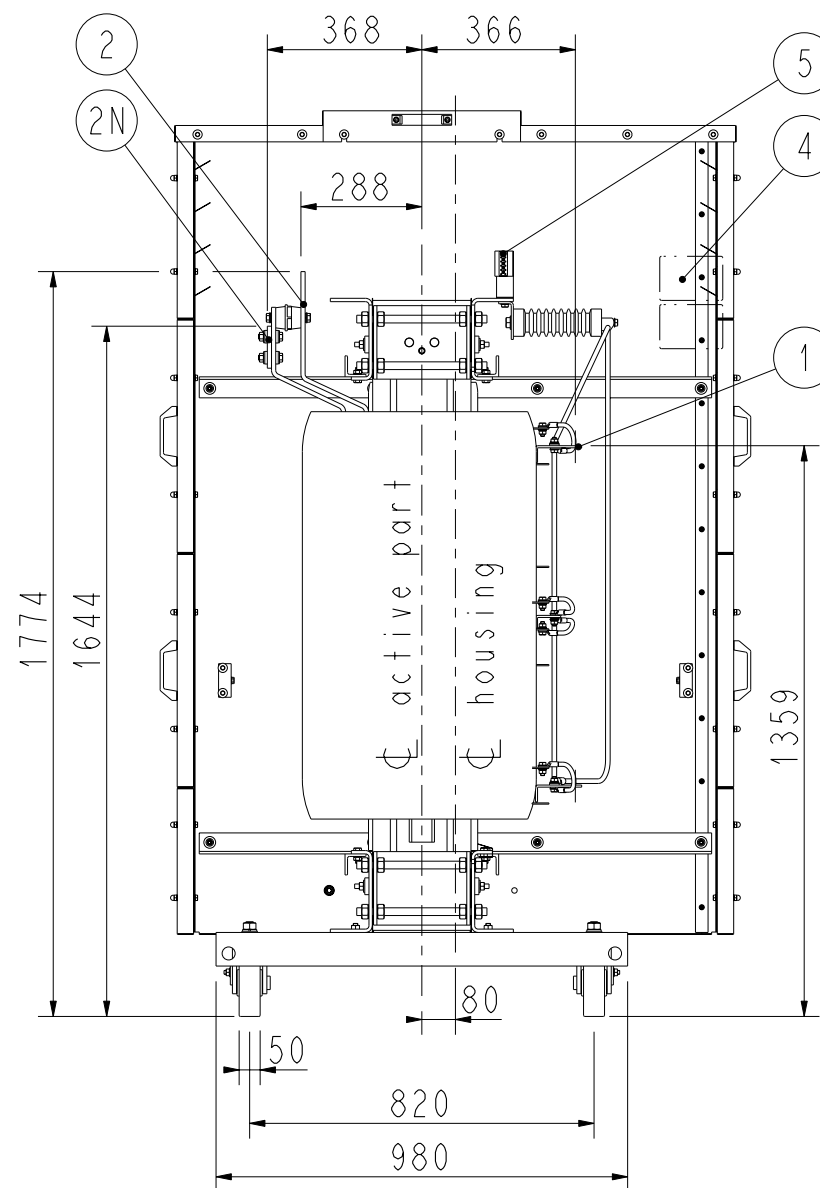
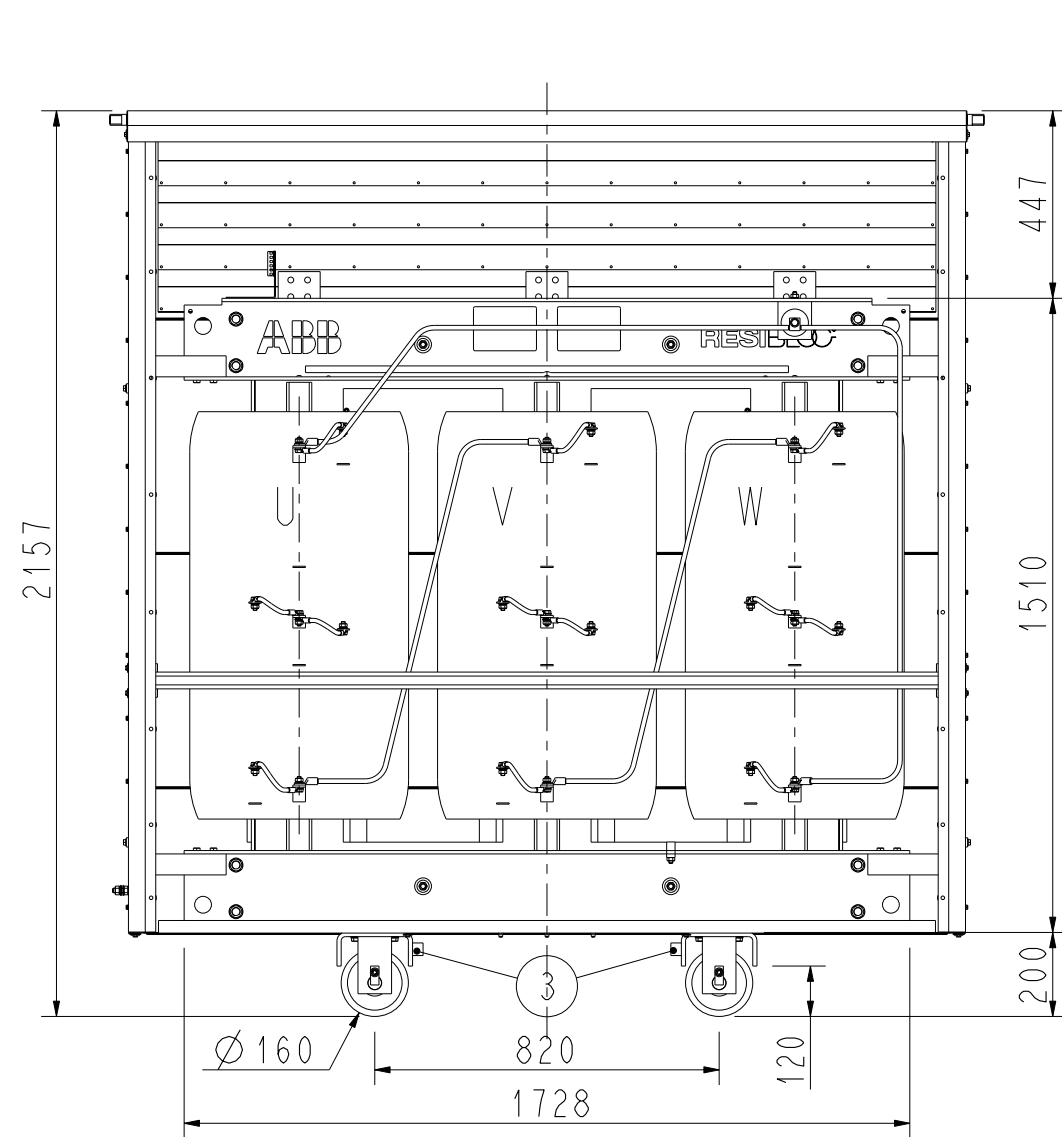

1	VN Pripojení / OS Anschluss
2	NN Pripojení / US Anschluss
2N	NN Uzel / US Sternpunkt
3	Uzemění M12 / Erdung M12
4	Výkonový Stitek / Leistungsschild
5	Teplotní Ochrana S PTC / Klemmleiste

Trifázový suchý transformátor / 3-Phasen Trockentransformator
Type / Typ RESIBLOC

Jmen. Výcon / Leistung	[kVA]	1250
Jmen. Napět na VN Straně / Spannung OS [V]		22000 ±2x2.5%
Jmen. Napět na NN Straně / Spannung US [V]		400
Spojení / Schaltgruppe		Dyn5
Stupen Ocrany / Schutzart		IP23
Frekvence / Frequenz	[Hz]	50
Trida Izolace / Isol. Klasse		F
Celkova Hmotnost / Gesamtgewicht	[kg]	3580

RevInd	Revision	Appd	Date
Prepared <i>Frigger</i>	Date 19.04.04	Responsible department BT	Title Zákaznický Výkres Massbild
Approved	Date	Take over Department	File: <auftrag>\trafo\massbild.drw
ABB Transformatoren GmbH			Document No. 1250-10023-24
			Language de
			Sheet 1/1