

Max. Rozměry / max. Abmessungen
2323 x 1493 x 2737

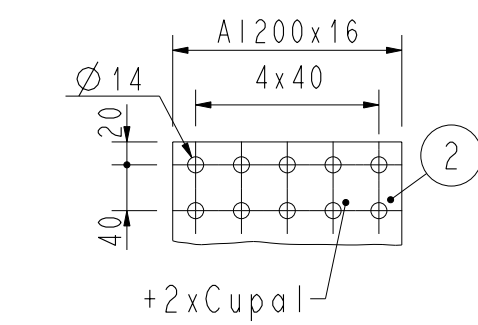
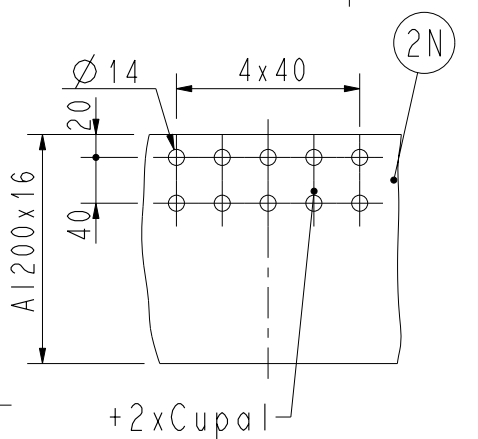
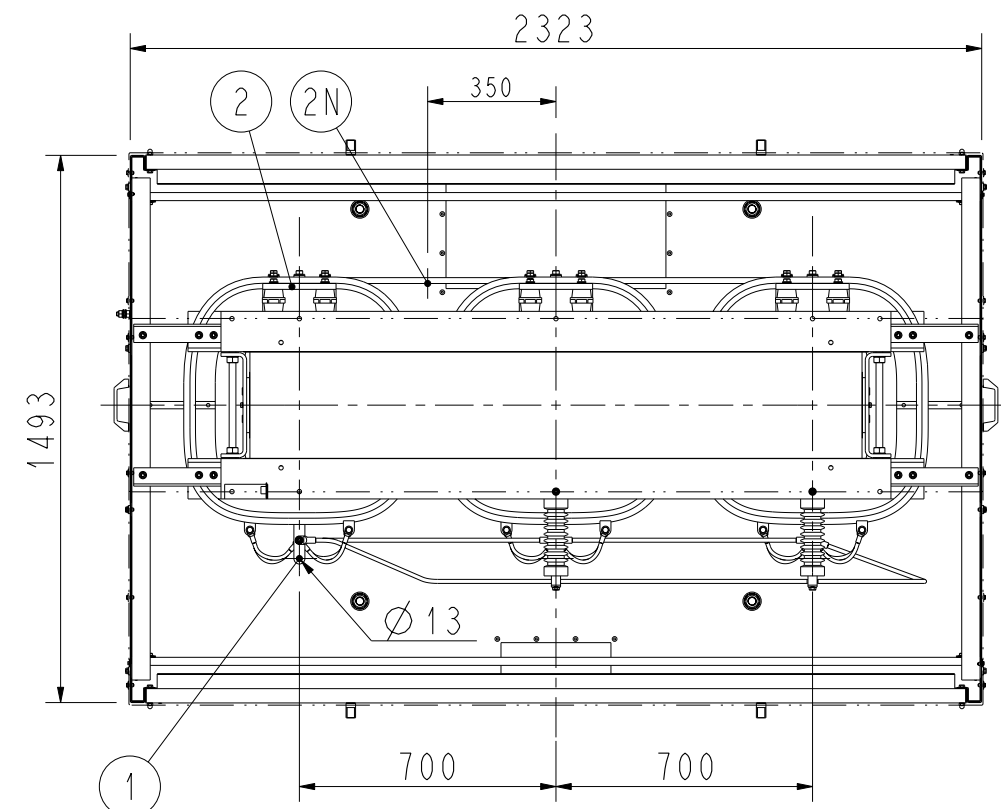
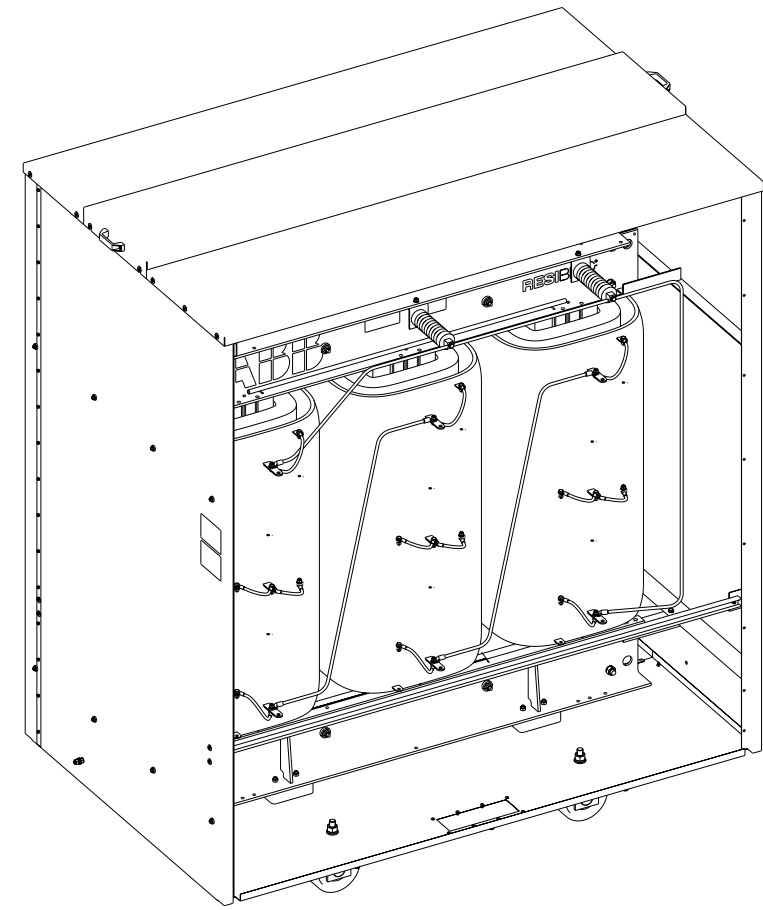
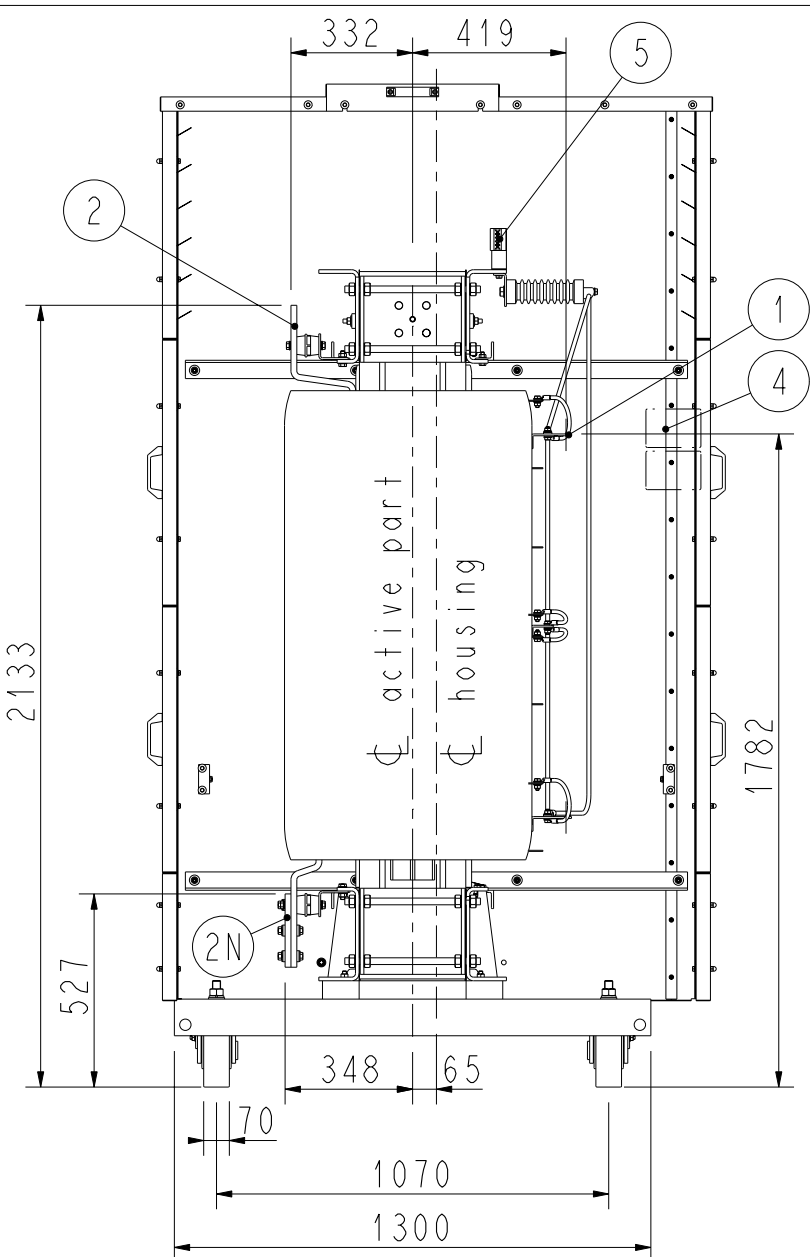
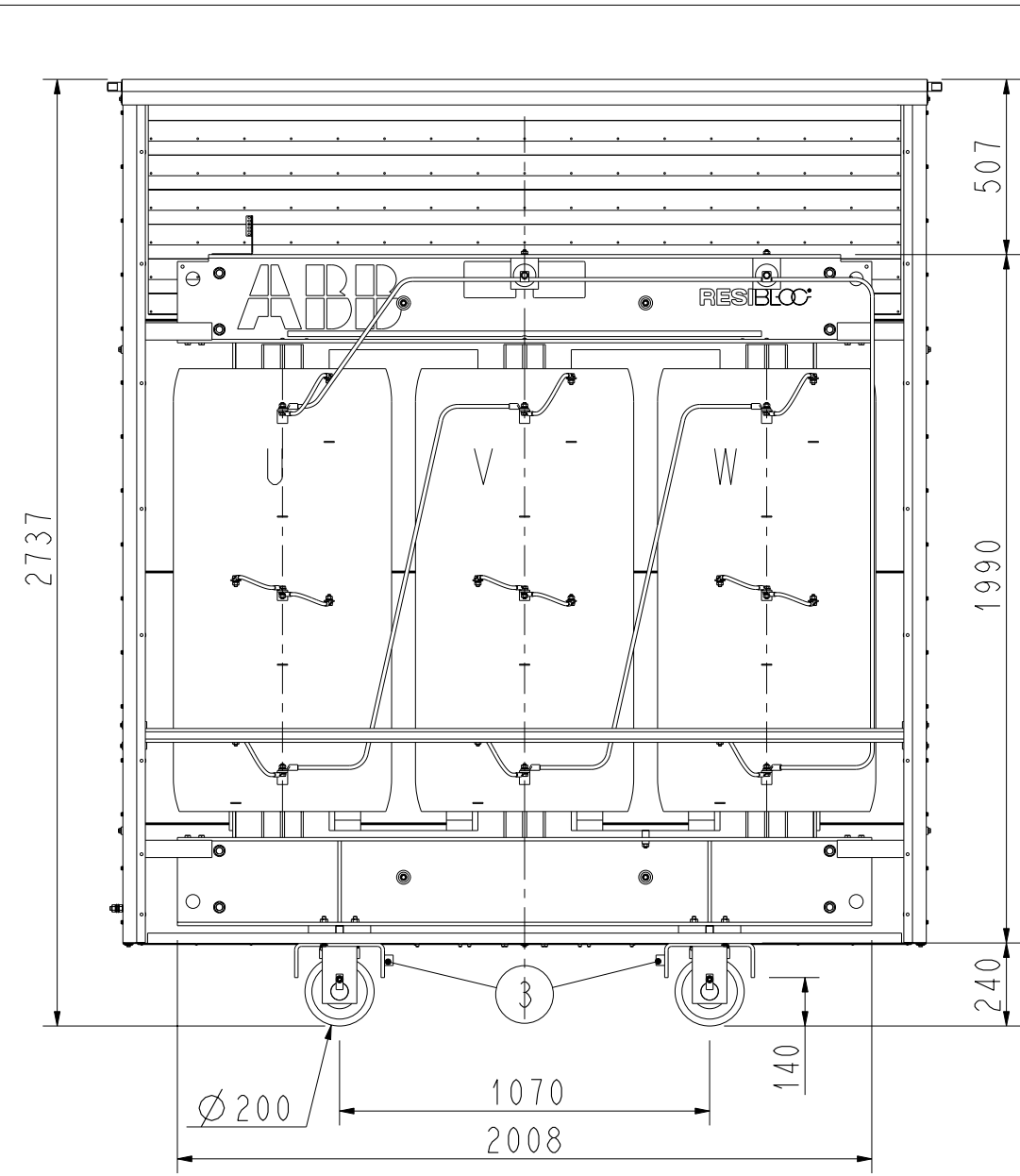

1	VN Pripojení / OS Anschluss
2	NN Pripojení / US Anschluss
2N	NN Uzel / US Sternpunkt
3	Uzemění M12 / Erdung M12
4	Výkonový Stitek / Leistungsschild
5	Teplotní Ochrana S PTC / Klemmleiste

Trifázový suchý transformátor / 3-Phasen Trockentransformator
Type / Typ RESIBLOC

Jmen. Výcon / Leistung [kVA] 3150
 Jmen. Napět na VN Straně / Spannung OS [V] 22000 ±2x2.5%
 Jmen. Napět na NN Straně / Spannung US [V] 400
 Spojení / Schaltgruppe Dyn5
 Stupen Ocrany / Schutzart IP23
 Frekvence / Frequenz [Hz] 50
 Trida Izolace / Isol. Klasse F
 Celkova Hmotnost / Gesamtgewicht [kg] 7060

RevInd	Revision	Appd	Date
Prepared <i>Frigger</i>	Date 19.04.04	Responsible department BT	Title Zákaznický Výkres Massbild
Approved	Date	Take over Department	File: <auftrag>\trafo\massbild.drw
ABB Transformatoren GmbH			Document No. 3150-10023-24
			Language de
			Sheet 1/1